

SHARP

MX-M1204
MX-M1054
MX-M904

Digital Multifunction System

High-Volume Performance Power
from a Durable Document Solution



A Light Production Powerhouse for

Designed for light production, Sharp's MX-M1204/M1054/M904 can deliver 120, 105, or 90 cpm/ppm of beautiful, high-quality B/W documents. Whether it's copies at 600 dpi or prints at 1,200 dpi, images and text are reproduced with exceptional clarity. Duplex scanning and sophisticated paper-feeding technology work to minimise paper misfeeds and enhance throughput speed and efficiency. Meanwhile, extra tray options expand paper capacity up to 13,500 sheets, making this MFP ideal for even the busiest CRD and copy room. With its exceptional security features and user-friendly control interface, this ultra-reliable document powerhouse is built to excel in a wide range of high-volume environments.

Saddle Stitch Finisher

Perfect for booklet making, this option automatically staples, punches holes*, and folds. With the addition of the optional Trimming Module, the edges of saddle-stitched documents can be trimmed to a beautifully consistent finish. A total of four optional Finishers are available to meet your application and paper-capacity needs.

* Requires separate Punch Module option.

Inserter

Thanks to two 200-sheet input trays that can handle different types of paper, the optional Inserter can add pre-printed covers and coloured pages to give documents a high-grade, professional look.



Folding Unit

This option performs five types of automated folding—z-fold, c-fold, accordion fold, double fold, and half-fold—for efficient production of direct mail and other items.

Stackers

Optional 5,000-sheet High Capacity Stackers with roll-out carts can be connected in tandem for unattended output of up to 10,000 sheets.

Your Toughest Document Demands

Reliability



Productivity



Usability



Duplex Single Pass Feeder

Because this highly reliable document feeder scans both sides of two-sided originals in one pass, large-volume documents can be scanned quickly and efficiently.

Status Indicator

The optional Status Indicator provides status alerts, including notice of errors, via green and red LED lights that can easily be seen from a distance.

10.1-Inch Colour Touchscreen LCD

A user-friendly touchscreen interface enables intuitive MFP operation. Document finishes and page layout can be confirmed onscreen before printing to prevent erroneous printouts and paper waste. And documents can be previewed in various modes to match the task at hand.

Multi-Bypass Tray

This option can feed in up to 500 sheets.

Curl Correction Unit

To ensure smooth paper transport, top and bottom rollers on this optional unit keep paper from warping.

Large Capacity Trays

Adding two 5,000-sheet Large Capacity Trays and a Multi-Bypass Tray expands the standard 3,100-sheet paper capacity to 13,500 sheets.

Reliability Builders

The MX-M1204/M1054/M904 was designed to maximise reliability and minimise downtime. Sturdy construction and features for smooth, uninterrupted paper feeding and printing ensure stable high-volume output and dependable operation.

Multi-Feed Detection System

A precision-engineered Multi-Feed Detection System on the MX-M1204 and the MX-M1054 employs ultrasonic technology to detect and diagnose misfeeds from the document feeder and the paper feed section of the paper trays.

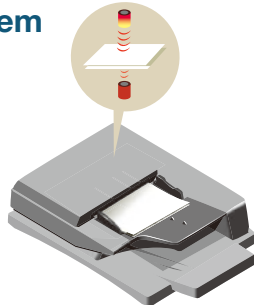

Curl Correction

For reliable output of two-sided copies and prints, the MX-M1204/M1054/M904 provides built-in curl correction to uncurl paper just after transfer. And for added stability, the optional Curl Correction Unit uses top and bottom rollers to apply pressure to convex and concave curls, preventing paper from warping before it goes to the finisher.



Triple Air-Feed System

The Triple Air-Feed System on the optional 5,000-sheet MX-LC13 Large Capacity Trays reliably separates and feeds in paper to facilitate jam-free operation and minimise downtime. Capable of supporting a wide range of paper types, this system employs air-feed technology and three precisely directed air flows for maximum reliability and proper paper handling.

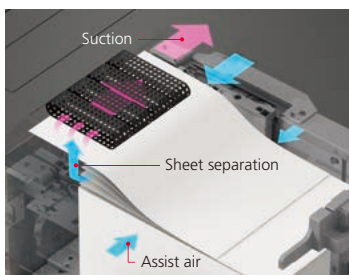

Highly Rigid Main Frame

A highly rigid support frame isolates and protects critical machine components in the MX-M1204/M1054/M904, ensuring increased durability and reliability. The unit can withstand heavy use in locations where rapid, high-volume output is demanded.

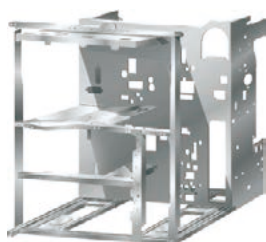

Intermediate Toner Hopper for Continuous Runs

Thanks to an intermediate toner hopper, there's no need to stop the MX-M1204/M1054/M904 during large-volume copy/print jobs when the toner cartridge needs changing. The MX-M1204/M1054/M904 can use toner from the toner hopper to continue printing while the empty toner cartridge is replaced with a new one.



Printing continues during toner cartridge replacement

Developer Cooling Systems

The developer unit in the MX-M1204/M1054/M904 employs a forced-air cooling system to prevent excessive heat build-up. This enables the unit to maintain consistent image quality, even in high-volume printing environments.



Full Front Access

Particularly convenient during toner cartridge replacement, an unlikely paper jam, and other operations, full front access to all key machine components ensures easy maintenance—and maximum uptime.



Mirroring Kit

To protect the MX-M1204/M1054/M904's enhanced data-handling capability and bring peace of mind, the optional Mirroring Kit provides hard disk backup. In the event that one hard disk is damaged, the data will be saved safely on another disk, ensuring continued operation.

A Heavy-Duty Productivity Booster

Productivity is the key to success in high-volume environments. On the MX-M1204/M1054/M904, speedy output, smooth scanning, expandable paper capacity, and versatile paper handling streamline document workflow and put productivity on the fast track.

A Winning Combination of Speed and Power

Built to meet the rigorous, high-volume demands of offices, copy rooms, CRD, and corporate data centers, the MX-M1204/M1054/M904 delivers B/W copying and printing at the impressive speed of **120, 105, or 90 cpm/ppm**. Advanced technology, integrated network scanning, and flexible configurations expedite job processing and streamline document workflow like never before. And to bring productivity and reliability where it's needed most, this high-volume workhorse boasts a 1TB hard drive and 5GB of standard memory.

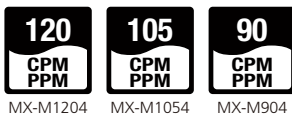

High-Efficiency Scanning

The MX-M1204/M1054/M904 can scan both pages of two-sided B/W and colour documents in one efficient pass. Capable of scanning one-sided A4-size (8½" x 11") documents at **120 opm*** and two-sided A4 documents at **200 opm***, the **250-sheet DSPF** (duplex single pass feeder) minimises paper misfeeds and brings fast, reliable operation.

*Originals per minute (when feeding A4-size documents at 200-dpi resolution)



Large Paper Capacity

While the MX-M1204/M1054/M904 holds a generous 3,100 sheets of paper, this standard capacity can be expanded to meet the needs of high-volume jobs. Adding an optional 500-sheet Multi-Bypass Tray and two 5,000-sheet (2,500 x 2) Large Capacity Trays boosts capacity to **13,500 sheets**. And when a tray runs out of paper, the **Auto Tray Switching** function automatically switches to another tray with the same-sized paper.

Versatile Paper Handling

The MX-M1204/M1054/M904 accommodates a wide range of paper sizes—from **A5R (5½" x 8½"R)** to **SRA3/A3 wide (12" x 18")**—and can provide **full-bleed copying and printing** on SRA3 paper. To further expand the range of printing applications, the MX-M1204/M1054/M904 supports paper weights up to **300 g/m²**.

Status Indicator

The optional Status Indicator provides diagnostics via green and red LED lights that are clearly visible from a distance. The green light remains lit while a job is being executed and blinks while document data is being read. The red light blinks or lights up to indicate an error that may or may not prevent normal operation.

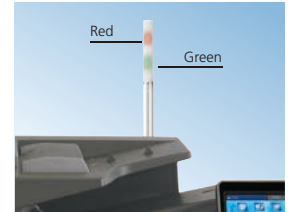

Document Management on the Hard Disk

To boost information sharing and distribution, processed job data can be saved in designated folders on the MX-M1204/M1054/M904's built-in hard disk for instant recall, printing, or sending at a later time. Data for frequently used template documents can also be saved on the hard disk, enabling quick and easy output for enhanced productivity.

Network Tandem Output

When two MX-M1204/M1054/M904s are connected to the same office network, they can be used simultaneously to double copy/print output to up to **240 cpm/ppm**. Large-volume jobs can be completed with ease, ensuring that tight deadlines will be met.

High Capacity Stacker

With an optional High Capacity Stacker, the MX-M1204/M1054/M904 can accommodate up to 5,000 sheets, expandable to **10,000 sheets** when two stackers are connected. Each stacker comes with a roll-out **Paper Cart** for effortless and efficient transport.



Fine Finishes from a Host of Options

For professional-looking documents and the easy automation of time-consuming finishing tasks, the MX-M1204/M1054/ M904 supports a variety of options covering a wide range of business needs. Modular units make it easy to build flexible configurations precisely suited to user needs.

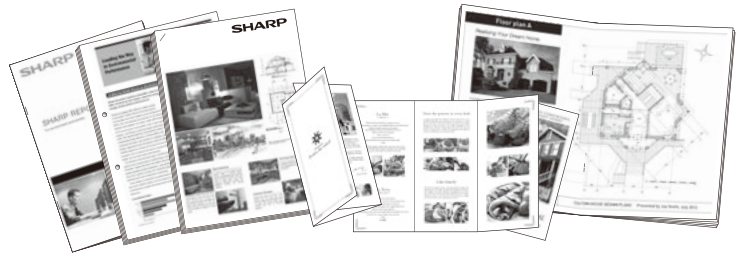

Stapling and Punching

With a maximum output capacity of 4,250 sheets, handy Finishers provide three stapling positions—front corner, rear corner, and two-point side—for up to 50 sheets (MX-FN25/FN24) or 100 sheets (MX-FN22/FN21) per set. Two-to-four-hole punching is available as an option.

• Stapling Positions (MX-FN22/FN21)

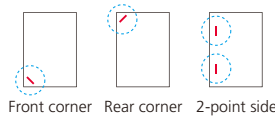

• Stapling Positions (MX-FN25/FN24)

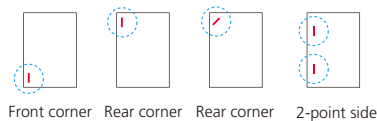

• Punching Positions

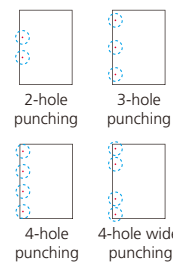

Saddle Stitching

In addition to conventional stapling, MX-FN25/FN22 Saddle Stitch Finishers can staple and fold sets of documents—up to 15 sheets for MX-FN25 and up to 20 sheets for MX-FN22.

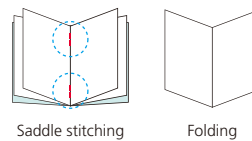

Trimming

For professional-looking booklets, Saddle Stitch Finishers can be equipped with a Trimming Module that gives the edges of saddle-stitched documents a beautifully consistent finish.

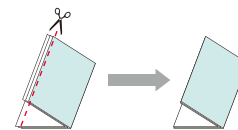

A Variety of Folds

The MX-FD10 Folding Unit automates various types of folding, such as z-folding and c-folding, for efficient production of direct mail, brochures, and more.

*1: For A3- and A4R-size paper

*2: For A4R-size paper

*3: For A4R-size paper (also for A3 paper with MX-FN25 option; for SRA3 and A3 paper with MX-FN22 option)

• Fold Variations

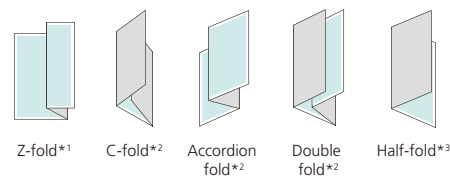

Insertion

For truly professional results, the Inserter can add pre-printed covers and insert paper up to 220 g/m² to documents before final finishing. Two input trays, each with a capacity of 200 sheets, make it possible to feed in two different types of paper.

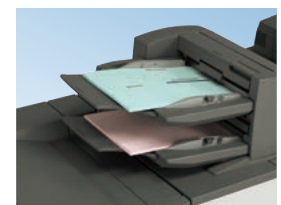
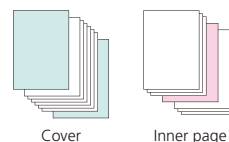

Exceptional Ease of Use

10.1-Inch Colour Touchscreen LCD

MFP operation has never been so intuitive, so easy. The control panel on the MX-M1204/M1054/M904 features a clear, wide WSVGA touchscreen LCD, ensuring that simple hand gestures applied to the screen bring effortless control of every document, function, and setting. With its user-friendly operation and easy customisation, this high-resolution touchscreen boosts productivity to the next level.

Advanced Preview

The Advanced Preview function saves you time and effort by showing scanned images on the LCD as thumbnail displays for easy confirmation and editing. Page layout, stapling, and other aspects of document finishing can be checked before documents are printed. Pages can be previewed in 3D, rotated, put in a different order, or deleted via touch-and-drag editing on the LCD. You can even erase specific pages and insert blank pages.



Thumbnail preview



Customisable Screen

The Home screen can be customised for individual users. Background images can be changed and personalised. The names and onscreen layout of function keys can be tailored to your convenience. And user-specific **shortcut keys** can be created for quick and easy access to frequently used MFP functions. There's even a choice of six screen colours and various screen languages, making it easy to set up a user interface that precisely meets the user's needs. An **Enlarge Display** mode brings added readability.



Action Panel

The Action Panel appears on the right side of the touchscreen to guide you through operational procedures. The MX-M1204/M1054/M904 intuitively suggests what actions to take next, and the Action Panel displays shortcut keys and messages pertaining to those actions.

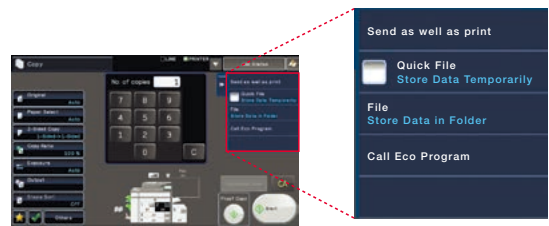

Action panel

Web Browsing

The optional Web Browsing Expansion Kit gives you direct access to the Internet for easy browsing of Web sites on the MX-M1204/M1054/M904's 10.1-inch colour touchscreen LCD.

Tiltable Control Panel

The large 10.1-inch LCD panel can be tilted from front to back and from side to side, providing greater visibility and improved ease of use—even from a wheelchair.



Other Advanced Usability Features

Retractable Keyboard

The optional full-size retractable QWERTY keyboard slides out from beneath the control panel for fast and easy text input, making tasks such as typing e-mail addresses, messages, and user authentication passwords a breeze.



Easy-Grip Handles

Easy-grip handles with a lock mechanism allow the paper drawers to be grasped from the top as well as the bottom for smooth and safe opening and closing.



Remarkable Image Quality

Mycrostoner-EP

Sharp's proprietary Mycrostoner-EP ensures optimum density and edge definition for the superb reproduction of fine lines and halftone colours. And while Mycrostoner-EP enables high-quality printing of photographs and illustrations, it also maximises toner yield and minimises waste.

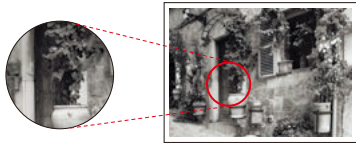

High-Resolution Output

The MX-M1204/M1054/M904 delivers **600-dpi** copying and razor-sharp **1,200-dpi** printing—without sacrificing output speed. Fine-grained photographs, detailed illustrations and graphs, and small text all come out crisp and clear.

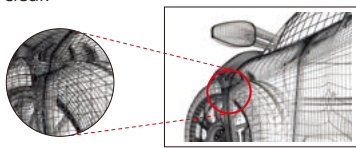

Standard PCL®6 and True Adobe® PostScript® 3™

For improved graphics handling and enhanced font compatibility, the MX-M1204/M1054/M904 comes standard with both PCL6 and true Adobe PostScript 3. The custom print drivers for Adobe PostScript 3 provide extensive job control options, enabling easy desktop management of document output.

Enhanced Scan Performance

Background Suppression

A function of Auto Colour Mode, the automatic suppression of unnecessary background colour is essential to achieving crisp, clear, natural-looking images. The MX-M1204/M1054/M904 provides enhanced background suppression without losing colour balance, resulting in scanned images that closely match the original.

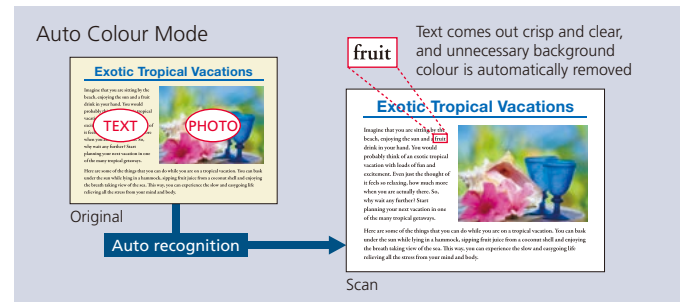

Colour Reproduction

Enhanced scan performance improves the legibility of extremely fine text and allows natural colour reproduction in scanned documents. Even delicate human skin tones can be reproduced naturally, without excessive colouration.

Halftone Process Control

Halftone process control brings optimal monochrome gradation and outstanding image quality to high-volume copy/print jobs. Employing an image density sensor to enhance the stability and accuracy of each gradation, halftone process control ensures consistently high image quality from first page to last.

Eco-Friendly Advances

Reduced Power Consumption

The technologies described here dramatically reduce power consumption and give the MX-M1204/M1054/M904 a smaller environmental footprint than previous models. And because of its reduced power consumption, the MX-M1204/M1054/M904 boasts lower TEC values* than the maximum allowable values determined by ENERGY STAR®. A shorter warm-up time brings additional convenience.

*Typical amount of energy consumed in a hypothetical week measured as stipulated under the ENERGY STAR® programme.

LED Lamps

Energy-efficient LED lamps employed in the scan unit (instead of conventional xenon lamps) provide further energy savings.

Biomass Plastic and Toner

The MX-M1204/M1054/M904's use of carbon-neutral biomass plastic and toner makes it an exceptionally environment-friendly MFP. Employing biomass materials helps reduce CO₂ emissions and lessens environmental impact.

Auto Power Shut-Off Mode

Based on usage patterns established over a four-week period, Auto Power Shut-Off mode automatically determines the optimal length of time to let elapse before shutting the power off. To accommodate intensive use of the MX-M1204/M1054/M904 on a specific day or time, users can manually set the elapse time to suit their specific usage patterns.

Power ON/OFF Scheduling

The Power ON/OFF Schedule function automatically turns the MX-M1204/M1054/M904 on or off according to time schedules set by the system administrator.

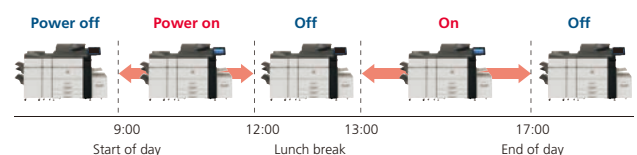

Eco Scan

To save energy, the Eco Scan function keeps the fusing system shut down during jobs that don't require its use, such as Image Sending and Document Filing.

Multi-Layer Security

Data Encryption and Overwriting

MFPs can retain hundreds of pages of confidential information from previous jobs on their hard disks or internal memory. To safeguard such information from unauthorised access, the MX-M1204/M1054/M904 automatically **encrypts** document data stored on the hard disk, including in the address book. Standard-equipped security features also provide up to seven automatic **overwrites** of data generated for each job, **password protection** of Document Filing data, and more.

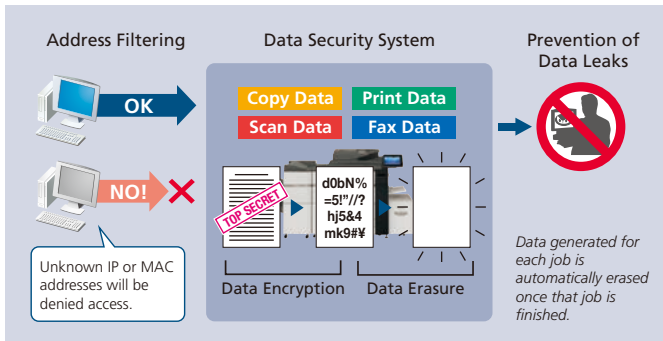

Note: Contact a Sharp customer representative for details on activating these security functions.

Control Device Access over a Network

The MX-M1204/M1054/M904 offers **IPsec**, **SMB**, and extended support for **SSL Encryption** (Secure Sockets Layer). For maximum security, users can also take advantage of IP/MAC address filtering, protocol enable/disable functionality, and port management.

Expandable Document Solutions

Simplified System Settings

MFP features and settings, including address book control and document filing management, can be configured either through Web-based device management or from the MX-M1204/M1054/M904's control panel.

Network Utility Software

Sharp Remote Device Manager* (SRDM) gives administrators centralised control of their networked MFPs through a standard Web browser, making device cloning and other operations easier and more accessible.

*Contact a Sharp customer representative for details on using this function.

Remote Operation

The Remote Operation function lets you display the MFP's main control panel on your PC screen, allowing you to operate every major function directly from your desktop.* This function also enables the administrator to remotely guide an MFP user through necessary procedures.

* Requires VNC application.

Document Control*

The Document Control function prevents unauthorised copying, scanning, faxing, and filing of confidential documents by embedding copy prevention data onto a document. When that data is detected, any unauthorised attempts to copy are cancelled or result in only blank-page output.

* Requires optional MX-FR38U. May not work on certain types of documents or paper.

Tracking and Auditing Information

Sharp offers both built-in and additional hardware/firmware systems that allow users to control, access, and track usage of each device on the network.

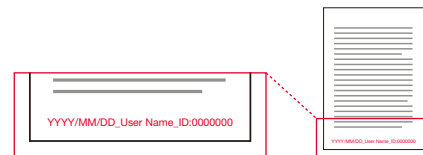

Hidden Pattern Copy/Print

With this function, a watermark, such as "Confidential" or "Not for Copy," can be embedded onto a document. If that document is copied, the watermark will appear, alerting the user not to distribute it.

Data Initialisation

The MX-M1204/M1054/M904's initialisation function allows confidential information to be erased. Initialising an MFP when it's time to replace it prevents important resources, such as customer information and intellectual property, from leaking out and provides considerable peace of mind.

Sharp OSA* (Open System Architecture)

As an innovative development platform, Sharp OSA allows you to interact with critical business and network applications right from the touchscreen LCD control panel, bringing a whole new realm of control and convenience. And since Sharp OSA utilises industry-standard network protocols, the MX-M1204/M1054/M904 can easily integrate with document management systems, software for enterprise resource planning, workflow applications, and more. The latest version of Sharp OSA can **reach beyond the firewall**, enabling extensive system construction and services over the Internet. Other benefits of bringing Sharp OSA on board include the reduction of costs associated with system implementation and management and the ability to share data across company branch offices or subsidiaries.

* Requires optional MX-AMX2 and/or MX-AMX3.

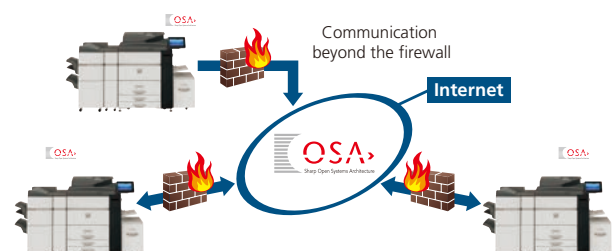

A Variety of Options for Flexible Configuration

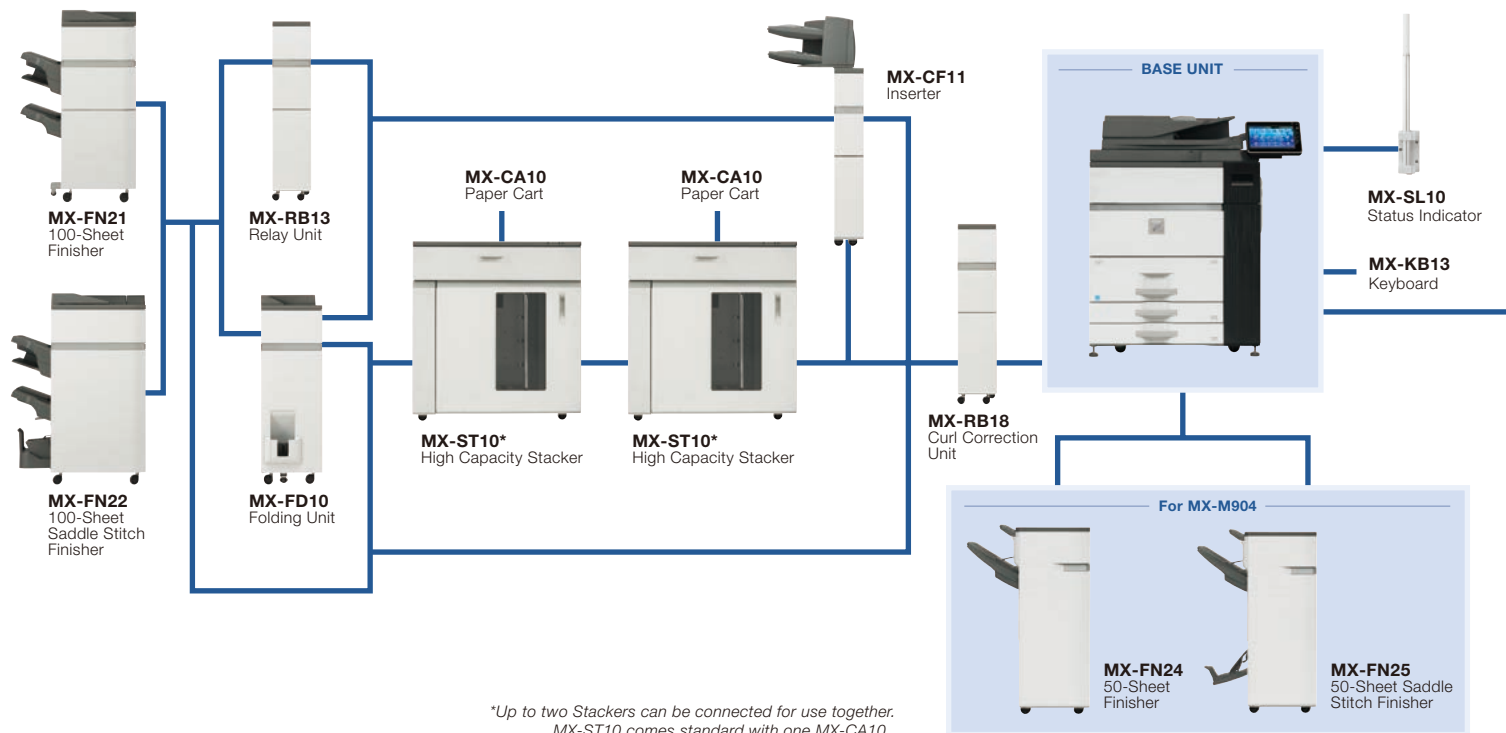

System Configuration Examples

Functions			Required Options	Example A	Example B	Example C	Example D
Output	Stapling	Up to 50 sheets	MX-FN24 or MX-FN25	●	—	—	—
		Up to 100 sheets	MX-FN21 or MX-FN22	—	●	●	●
	Hole Punching	52 g/m ² –176 g/m ²	MX-FN24 or MX-FN25	●	—	—	—
		52 g/m ² –256 g/m ²	MX-FN21 or MX-FN22	—	●	●	●
	Saddle Stitching	Up to 15 sheets	MX-FN25	—	—	—	—
		Up to 20 sheets	MX-FN22	—	—	●	●
	Folding	Half-folding	MX-FN22 or MX-FN25 or MX-FD10	—	—	●	●
		Z, C, Accordion, Double folding	MX-FD10	—	—	—	●
	Trimming	High-quality finishes	MX-TM10	—	—	●	●
	Inserting	Two-bin Inserter	MX-CF11	—	—	●	●
Stacking	Up to 5,000 sheets	MX-ST10	—	—	—	—	
	Up to 10,000 sheets	MX-ST10 x 2	—	—	—	●	
Extra Paper Feed	1-Tray Paper Feeding	Plus 3,500 sheets (max. A4)	MX-LC12	●	●	—	—
		Plus 3,000 sheets (max. A3)	MX-LCX3 N	—	—	—	—
	2-Tray Paper Feeding	Plus 5,000 sheets (max. A3)	MX-LC13	—	—	●	●
		Plus 10,000 sheets (max. A3)	MX-LC13 x 2	—	—	—	●
	Manual Paper Feeding	Plus 500 sheets	MX-MF11	—	—	●	●
		Plus 100 sheets	MX-MFX1	●	●	—	—
Others	Typing	Retractable QWERTY keyboard	MX-KB13	—	—	●	●
	Curl Correcting	Pressure on convex/concave curl	MX-RB18	—	●	●	●
	Document Transporting	Extra Paper Cart	MX-CA10	—	—	—	●
	Indicating Status	Status Indicator	MX-SL10	—	—	—	●

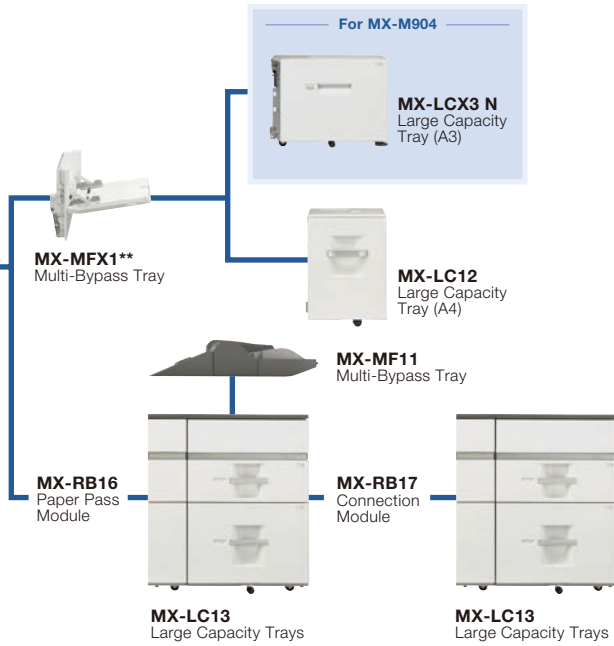

**Required for minimum configuration

- MX-PN13A/B/C/D**
Punch Module (for MX-FN21/22)
- MX-PNX4A/B/C/D**
Punch Module (for MX-FN24/25)
- MX-TM10**
Trimming Module (for MX-FN22)
- MX-PUX1**
XPS Expansion Kit
- MX-PF10**
Barcode Font Kit
- MX-AM10**
Web Browsing Expansion Kit
- AR-SU1**
Stamp Unit
- MX-FX11**
Fax Expansion Kit
- MX-FWX1**
Internet Fax Expansion Kit
- MX-USX1/X5**
Sharpdesk 1/5-License Kit
- MX-US10/50/A0**
Sharpdesk 10/50/100-License Kit
- MX-UN01A/05A**
Sharp OSA Network Scanner Tool 1/5-License Kit
- MX-UN10A/50A**
Sharp OSA Network Scanner Tool 10/50-License Kit
- MX-UN1HA**
Sharp OSA Network Scanner Tool 100-License Kit
- MX-AMX1**
Application Integration Module
- MX-AMX2**
Application Communication Module
- MX-AMX3**
External Account Module
- MX-EB11**
Enhanced Compression Kit
- MX-EB15**
Mirroring Kit
- MX-FR38U**
Data Security Kit

Example A With Stapling Function (MX-M904 only)



- Output Options**
- ① Finisher (50-sheet stapling) **MX-FN24**
 - ② Punch Module **MX-PNX4**
- Paper Feed Options**
- ③ Multi-Bypass Tray **MX-MFX1**
 - ④ Large Capacity Tray (A4) **MX-LC12**

Example B With Stapling Function



- Output Options**
- ① Curl Correction Unit **MX-RB18**
 - ② Finisher (100-sheet stapling) **MX-FN21**
 - ③ Punch Module **MX-PN13**
- Paper Feed Options**
- ④ Multi-Bypass Tray **MX-MFX1**
 - ⑤ Large Capacity Tray (A4) **MX-LC12**

Example C With Booklet Function



- Output Options**
- ① Curl Correction Unit **MX-RB18**
 - ② Saddle Stitch Finisher (100-sheet stapling) **MX-FN22**
 - ③ Punch Module **MX-PN13**
 - ④ Trimming Module **MX-TM10**
- Paper Feed Options**
- ⑤ Inserter **MX-CF11**
 - ⑥ Relay Unit **MX-RB13**
 - ⑦ Paper Pass Module **MX-RB16**
 - ⑧ Large Capacity Trays **MX-LC13**
 - ⑨ Multi-Bypass Tray **MX-MF11**
- Other Options**
- ⑩ Keyboard **MX-KB13**

Example D Full Configuration



- Output Options**
- ① Curl Correction Unit **MX-RB18**
 - ② High Capacity Stacker **MX-ST10**
 - ③ Folding Unit **MX-FD10**
 - ④ Saddle Stitch Finisher (100-sheet stapling) **MX-FN22**
 - ⑤ Punch Module **MX-PN13**
 - ⑥ Trimming Module **MX-TM10**
- Other Options**
- ⑦ Keyboard **MX-KB13**
 - ⑧ Status Indicator **MX-SL10**
 - ⑨ Paper Cart (Extra) **MX-CA10**
- Paper Feed Options**
- ⑩ Inserter **MX-CF11**
 - ⑪ Paper Pass Module **MX-RB16**
 - ⑫ Large Capacity Trays **MX-LC13**
 - ⑬ Multi-Bypass Tray **MX-MF11**
 - ⑭ Connection Module **MX-RB17**

SPECIFICATIONS (tentative)

General	
Type	Console
Engine speed	Max. 120/105/90 cpm/ppm (A4, 8 1/2" x 11", long-edge feeding)
Paper size	Max. SRA3/A3 wide (12" x 18"), min. A5R (5 1/2" x 8 1/2"R)
Paper capacity (80 g/m ²)	Standard: 3,100 sheets (1200-, 800-, 2x500-sheet trays and 100-sheet multi-bypass tray) Maximum: 13,500 sheets
Paper weight	Trays 1&2: 60 g/m ² to 105 g/m ² (16 lbs bond to 28 lbs bond) Trays 3&4: 60 g/m ² to 220 g/m ² (16 lbs bond to 80 lbs cover) Multi-bypass tray (MX-MFX1): 52 g/m ² to 300 g/m ² (13 lbs bond to 110 lbs cover) Multi-bypass tray (MX-MF11): 52 g/m ² to 220 g/m ² (13 lbs bond to 80 lbs cover) Large capacity tray (MX-LC12, MX-LCX3 N): 60 g/m ² to 220 g/m ² (16 lbs bond to 80 lbs cover) Large capacity trays (MX-LC13): 52 g/m ² to 300 g/m ² (13 lbs bond to 110 lbs cover)
Warm-up time*1	210 sec.
Memory	Copy/print (shared): 2GB (5GB) 1TB HDD*2
Power requirements	MX-M904: 220-240V / 10A and 220-240V / 2A, 50/60Hz MX-M1054/M1204: 220-240V / 13A, 50/60Hz
Power consumption (max.)	MX-M904: 2.3 kW + 0.46 kW MX-M1054/M1204: 2.99 kW
Dimensions (W x D x H)	1,084 x 790 x 1,237mm [(approx.) 42 3/4" x 31 1/4" x 48 3/4"]
Weight (approx.)	295 kg (650.4 lbs)

Copier	
Original paper size	Max. A3 (11" x 17")
First copy time*3	MX-M904: 4.0 sec., MX-M1054/M1204: 3.2 sec.
Continuous copy	Max. 9,999 copies
Resolution	Scan: 600 x 600 dpi, 600 x 400 dpi, 600 x 300 dpi Print: 1200 x 1200 dpi, 600 x 600 dpi
Gradation	Equivalent to 256 levels
Zoom range	25 to 400% (25 to 200% using DSPF) in 1% increments
Pre-set copy ratios	Metric: 10 ratios (5R/5E), Inch: 8 ratios (4R/4E)

Network Scanner	
Scan method	Push scan (via control panel), pull scan (TWAIN-compliant application)
Resolution	Push scan: 100, 150, 200, 300, 400, 600 dpi Pull scan: 75, 100, 150, 200, 300, 400, 600 dpi 50 to 9,600 dpi via user setting
File formats	Monochrome: TIFF, PDF, PDF/A, Encrypted PDF, XPS*4 Colour/Grayscale: TIFF, JPEG, PDF, Compact PDF*5, PDF/A, Encrypted PDF, XPS*4
Scanner utility	Sharpdesk
Scan destinations	Scan to e-mail/desktop/FTP server/network folder (SMB)/USB memory

Document Filing	
Document filing capacity*6	Main and custom folders: 35,000 pages or 5,000 files Quick file folder: 10,000 pages or 1,000 files
Stored jobs	Copy, print, scan, fax
Storage folders	Quick file folder, main folder, custom folder (max. 1,000 folders)
Confidential storage	Password protection (for main and custom folders)

Network Printer	
Resolution	1,200 x 1,200 dpi, 600 x 600 dpi
Interface	USB 2.0, 10Base-T/100Base-TX/1000Base-T
Supported OS	Windows Server® 2003/2008/2012, Windows® XP, Windows Vista®, Windows® 7/8 Mac OS X10.4, X10.5, X10.6, X10.7, X10.8
Network protocols	TCP/IP (IPv4, IPv6), IPX/SPX (NetWare), EtherTalk (AppleTalk)
Printing protocols	LPR, Raw TCP (port 9100), POP3 (e-mail printing), HTTP, NetBEUI, FTP for downloading print files, EtherTalk printing, IPP
PDL	Standard: PCL 6 emulation, Adobe® PostScript® 3™ Option*7: XPS
Available fonts	80 fonts for PCL, 136 fonts for Adobe® PostScript® 3™

B/W Facsimile (optional MX-FX11 required)	
Compression method	MH/MR/MMR/JBIG
Communication protocol	Super G3/G3
Transmission time	Less than 3 seconds*8
Modem speed	33,600 bps to 2,400 bps with automatic fallback
Transmission resolution	From Standard (203.2 x 97.8 dpi) to Ultra Fine (406.4 x 391 dpi)
Recording width	A3 to A5 (11" x 17" to 5 1/2" x 8 1/2")
Memory	1GB (built-in)
Grey scale levels	Equivalent to 256 levels

- *1: At rated voltage, 23°C (73.4°F). May vary depending on operating conditions and environment.
- *2: HDD capacity depends on procurement and sourcing status.
- *3: Long-edge feeding of A4 (8 1/2" x 11") sheets from 2nd paper tray, using document glass, MFP in fully ready condition. May vary depending on operating conditions and environment.
- *4: To view XPS files on PCs not running Windows Vista, you must have the XPS Viewer application installed.
- *5: Optional MX-EB11 required.
- *6: Storage capacity will vary depending on the type of document and the scan settings.
- *7: Optional MX-PUX1 required.
- *8: Based on Sharp's standard chart with approx. 700 characters (A4 or 8 1/2" x 11" long-edge feeding) at standard resolution in Super G3 mode, 33,600 bps, JBIG compression.

- Design and specifications are subject to change without prior notice.
- Windows, Windows Server, Windows Vista, and Excel are registered trademarks of Microsoft Corporation in the United States and/or other countries. Adobe and PostScript 3 are either registered trademarks or trademarks of Adobe Systems Incorporated in the United States and/or other countries. All other brand names and product names may be trademarks or registered trademarks of their respective owners.
- The ENERGY STAR logo is a certification mark and may only be used to certify products that have been determined to meet the ENERGY STAR programme requirements. ENERGY STAR is a US registered mark. The ENERGY STAR guidelines apply to products only in the US, the EU, Japan, Canada, Australia, New Zealand, and Taiwan.

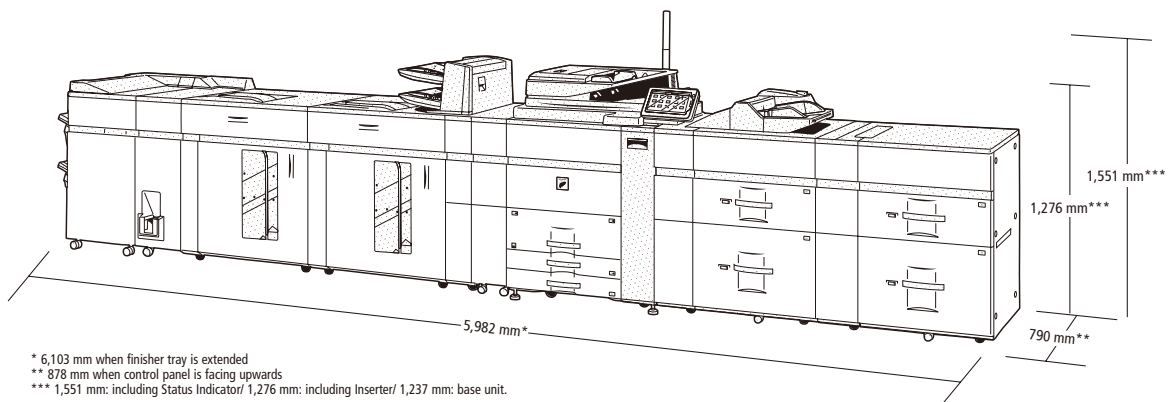

* 6,103 mm when finisher tray is extended
 ** 878 mm when control panel is facing upwards
 *** 1,551 mm: including Status Indicator/ 1,276 mm: including Inserter/ 1,237 mm: base unit.

Shown with options.

Distributed by: